

**ST150/160**  
**Ultrasonic Thickness Gauge**  
**User's Manual**

1 Overview .....	3
1.1 Product Specifications .....	3
1.2 Main Functions .....	4
1.3 Measuring Principle .....	4
1.4 Configuration .....	5
1.5 Operating Conditions .....	6
2 Structure Feature .....	6
2.1 Main Screen.....	7
2.2 Keypad Definitions .....	8
3 Preparation .....	9
3.1 Transducer Selection .....	9
3.2 Condition and Preparation of Surfaces .....	13
4 Operation .....	14
4.1 Power On/Off.....	14
4.2 Probe Zero.....	14
4.3 Sound Velocity Calibration .....	15
4.4 Making Measurements .....	19
4.5 Scan mode.....	20
4.6 Changing Resolution .....	21
4.7 Changing Units.....	22
4.8 Memory Management.....	22
4.9 Data Printing.....	24
4.10 Beep Mode .....	24
4.11 EL Backlight.....	24
4.12 Battery Information .....	25
4.13 Auto Power Off .....	25
4.14 System Reset .....	25

4.15 Connecting to a Computer .....	25
5 Servicing .....	26
6 Transport and Storage .....	26
Appendix A Sound Velocities.....	27
Appendix B Applications Notes.....	28

# 1 Overview

The model ST150/ST160 is a digital ultrasonic thickness gauge. Based on the same operating principles as SONAR, the instrument is capable of measuring the thickness of various materials with accuracy as high as 0.1/0.01 millimeters. It is suitable for a variety of metallic and non-metallic materials.

## 1.1 Product Specifications

- 1) Display : 4.5 digits LCD with EL backlight.
- 2) Measuring Range : (0.75 ~ 300)mm (in Steel).
- 3) Sound Velocity Range: (1000~9999) m/s.
- 4) Resolution : ST150: 0.1mm; ST160: 0.1mm/0.01mm
- 5) Accuracy :  $\pm ( 0.5\% \text{Thickness} + 0.04 )$  mm, depends on materials and conditions
- 6) Units: Metric/Imperial unit selectable.
- 7) Four measurements readings per second for single point measurement, and ten per second for Scan Mode.
- 8) Memory for up to 20 files (up to 99 values for each file) of stored values.
- 9) Power Source :Two "AA" size, 1.5 Volt alkaline batteries. 100 hours typical operating time (EL backlight off).
- 10) Communication : RS232 serial port for ST160. No communication port for ST150.
- 11) Outline dimensions : 150mm×74mm×32 mm.
- 12) Weight : 245g

## **1.2 Main Functions**

- 1) Capable of performing measurements on a wide range of material, including metals, plastic, ceramics, composites, epoxies, glass and other ultrasonic wave well-conductive materials.
- 2) Transducer models are available for special application, including for coarse grain material and high temperature applications.
- 3) Probe-Zero function, Sound-Velocity-Calibration function
- 4) Two-Point Calibration function.
- 5) Two work modes: Single point mode and Scan mode.
- 6) Coupling status indicator showing the coupling status.
- 7) Battery information indicates the rest capacity of the battery.
- 8) Auto sleep and auto power off function to conserve battery life.
- 9) Optional software to process the memory data on the PC for ST160.
- 10) Optional thermal mini-printer to print the measured data via RS232 port for ST160.

## **1.3 Measuring Principle**

The digital ultrasonic thickness gauge determines the thickness of a part or structure by accurately measuring the time required for a short ultrasonic pulse generated by a transducer to travel through the thickness of the material, reflect from the back or inside surface, and be returned to the transducer. The measured two-way transit time is divided by two to account for the down-and-back travel path, and then multiplied by the velocity of sound in the material.

The result is expressed in the well-known relationship:

$$H = \frac{v \times t}{2}$$

Where : H - Thickness of the test piece.

v - Sound Velocity in the material.

t - The measured round-trip transit time.

## 1.4 Configuration

Table 1-1

	No	Item	Quantity	Note
Standard Configuration	1	Main body	1	
	2	Transducer	1	Model: N05/90 °
	3	Couplant	1	
	4	Instrument Case	1	
	5	Operating Manual	1	
	6	Alkaline battery	2	AA size
	7			
	8			
Optional Configuration	9	Transducer: N02		See Table3-1
	10	Transducer: N07		
	11	Transducer: HT5		
	12	Mini thermal printer	1	Only for ST160.
	13	Print cable	1	
	14	DataPro Software	1	
	15	Communication Cable	1	

## 1.5 Operating Conditions

Operating Temperature: - 20 ~ + 60 ;

Storage Temperature : -30 ~ + 70

Relative Humidity 90% ;

The surrounding environment should avoid of vibration, strong magnetic field, corrosive medium and heavy dust.

## 2 Structure Feature

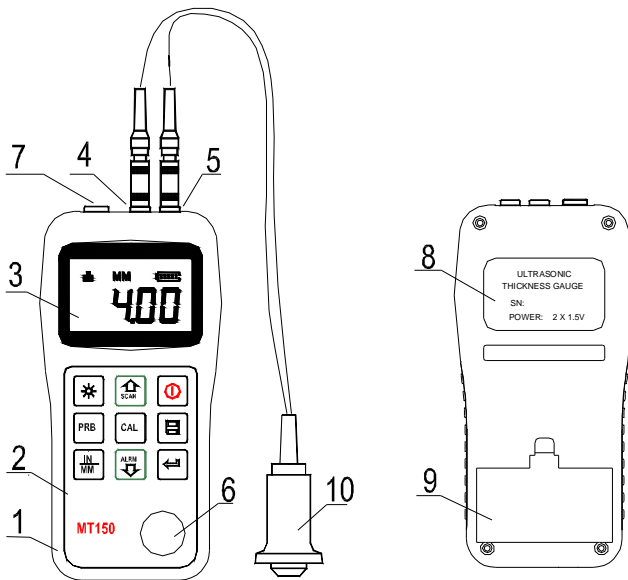

1 The main body 2 Keypad 3 LCD display 4 Pulser socket  
5 Receiver socket 6 Probe zero disc 7 Communication  
port 8 Label 9 Battery cover 10 Probe

## 2.1 Main Screen

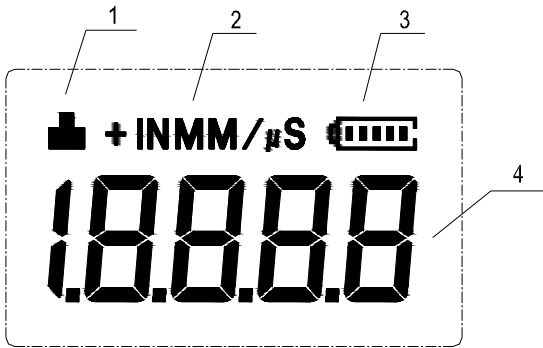









**1, Coupling Status:** Indicate the coupling status. While the gauge is taking a measurement, the coupling status should be on. If it is not on or not stable, the gauge is having difficulty achieving a stable measurement, and the thickness value displayed will most likely be erroneous.

**2, Unit:** Current unit system. MM or IN for thickness value. M/S or IN/μ S for sound velocity.

**3, Battery Information:** Display the rest capacity of the battery.

**4, Information Display:** Displays the measured thickness value, the sound velocity and shows hints of current operation.

## 2.2 Keypad Definitions

	Turn the instrument on/off		Sound velocity calibration
	Turn on/off the EL backlight		Enter
	Probe-Zero operation		Plus; Turn on/off Scan mode
	Unit switch between Metric and Imperial system		Minus; Turn on/off the beep mode
	Data Save or Data Delete		

## **3 Preparation**

### **3.1 Transducer Selection**

The gauge is inherently capable of performing measurements on a wide range of materials, from various metals to glass and plastics. Different types of material, however, will require the use of different transducers. Choosing the correct transducer for a job is critical to being able to easily perform accurate and reliable measurement. The following paragraphs highlight the important properties of transducers, which should be considered when selecting a transducer for a specific job.

Generally speaking, the best transducer for a job is one that sends sufficient ultrasonic energy into the material being measured such that a strong, stable echo is received by the gauge. Several factors affect the strength of ultrasound as it travels. These are outlined below:

**Initial Signal Strength.** The stronger a signal is to begin with, the stronger its return echo will be. Initial signal strength is largely a factor of the size of the ultrasound emitter in the transducer. A large emitting area will send more energy into the material being measured than a small emitting area. Thus, a so-called “1/2 inch” transducer will emit a stronger signal than a “1/4 inch” transducer.

**Absorption and Scattering.** As ultrasound travels through any material, it is partly absorbed. If the material through which the sound travels has any grain structure, the sound waves will experience scattering. Both of these effects reduce the strength of the waves, and thus, the

gauge's ability to detect the returning echo. Higher frequency ultrasound is absorbed and scattered more than ultrasound of a lower frequency. While it may seem that using a lower frequency transducer might be better in every instance, low frequencies are less directional than high frequencies. Thus, a higher frequency transducer would be a better choice for detecting the exact location of small pits or flaws in the material being measured.

Geometry of the transducer. The physical constraints of the measuring environment sometimes determine a transducer's suitability for a given job. Some transducers may simply be too large to be used in tightly confined areas. Also, the surface area available for contacting with the transducer may be limited, requiring the use of a transducer with a small wearface. Measuring on a curved surface, such as an engine cylinder wall, may require the use of a transducer with a matching curved wearface.

Temperature of the material. When it is necessary to measure on surfaces that are exceedingly hot, high temperature transducers must be used. These transducers are built using special materials and techniques that allow them to withstand high temperatures without damage. Additionally, care must be taken when performing a "Probe-Zero" or "Calibration to Known Thickness" with a high temperature transducer.

Selection of the proper transducer is often a matter of tradeoffs between various characteristics. It may be necessary to experiment with a variety of transducers in order to find one that works well for a given job.

The transducer is the “business end” of the instrument. It transmits and receives ultrasonic sound waves that the instrument uses to calculate the thickness of the material being measured. The transducer connects to the instrument via the attached cable, and two coaxial connectors. When using transducers, the orientation of the dual coaxial connectors is not critical: either plug may be fitted to either socket in the instrument.

The transducer must be used correctly in order for the instrument to produce accurate, reliable measurements. Below is a short description of the transducer, followed by instructions for its use.

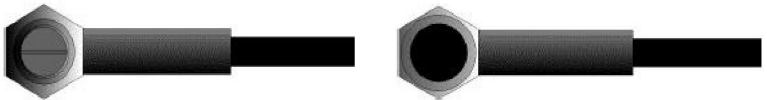

Left figure is a bottom view of a typical transducer. The two semicircles of the wearface are visible, as is the barrier separating them. One of the semicircles is responsible for conducting ultrasonic sound into the material being measured, and the other semicircle is responsible for conducting the echoed sound back into the transducer. When the transducer is placed against the material being measured, it is the area directly beneath the center of the wearface that is being measured.

Right figure is a top view of a typical transducer. Press against the top with the thumb or index finger to hold the transducer in place. Moderate pressure is sufficient, as it is

only necessary to keep the transducer stationary, and the wearface seated flat against the surface of the material being measured.

Table 3-1 Transducer Selection

Model	Freq MHz	Diam mm	Measuring Range	Lower limit	Description
N02	2.5	14	3.0mm ~ 300.0mm ( In Steel ) 40mm (in Gray Cast Iron HT200)	20mm	for thick, highly attenuating, or highly scattering materials
N05	5	10	1.2mm ~ 230.0mm ( In Steel )	20mm x 3.0mm	Normal Measurement
N05 /90 °	5	10	1.2mm ~ 230.0mm ( In Steel )	20mm x 3.0mm	Normal Measurement
N07	7	6	0.75mm ~ 80.0mm ( In Steel )	15mm x 2.0mm	For thin pipe wall or small curvature pipe wall measurement
HT5	5	14	3 ~ 200mm ( In Steel )	30mm	For high temperature (lower than 300 ) measurement.

### **3.2 Condition and Preparation of Surfaces**

In any ultrasonic measurement scenario, the shape and roughness of the test surface are of paramount importance. Rough, uneven surfaces may limit the penetration of ultrasound through the material, and result in unstable, and therefore unreliable, measurements. The surface being measured should be clean, and free of any small particulate matter, rust, or scale. The presence of such obstructions will prevent the transducer from seating properly against the surface. Often, a wire brush or scraper will be helpful in cleaning surfaces. In more extreme cases, rotary sanders or grinding wheels may be used, though care must be taken to prevent surface gouging, which will inhibit proper transducer coupling.

Extremely rough surfaces, such as the pebble-like finish of some cast iron, will prove most difficult to measure. These kinds of surfaces act on the sound beam like frosted glass on light, the beam becomes diffused and scattered in all directions.

In addition to posing obstacles to measurement, rough surfaces contribute to excessive wear of the transducer, particularly in situations where the transducer is “scrubbed” along the surface. Transducers should be inspected on a regular basis, for signs of uneven wear of the wearface. If the wearface is worn on one side more than another, the sound beam penetrating the test material may no longer be perpendicular to the material surface. In this case, it will be difficult to exactly locate tiny irregularities in the material being measured, as the focus of the sound beam no longer

lies directly beneath the transducer.

## 4 Operation

### 4.1 Power On/Off

The instrument is turned on by pressing the  key.

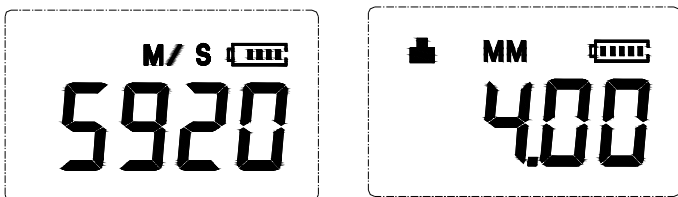



The gauge can be turned off by pressing the  key while it is on. The tool has a special memory that retains all of its settings even when the power is off.

### 4.2 Probe Zero

The  key is used to “zero” the instrument in much the same way that a mechanical micrometer is zeroed. If the gauge is not zeroed correctly, all the measurements that the gauge makes may be in error by some fixed value. When the instrument is “zeroed”, this fixed error value is measured and automatically corrected for all subsequent measurements. The instrument may be “zeroed ” by performing the following procedure.:

- 1) Plug the transducer into the instrument. Make sure that the connectors are fully engaged. Check that the wearface of the transducer is clean and free of any debris.
- 2) Press the  key to activate the probe zero mode.

- 3) Use the  key and the  key to scroll to the probe model currently being used. Be sure to set the right probe model to the instrument. Otherwise, there will be erroneous.
- 4) Apply a single droplet of ultrasonic couplant to the face of the metal probe-disc.
- 5) Press the transducer against the probe disc, making sure that the transducer sits flat against the surface.
- 6) Remove the transducer from the probe disc.

At this point, the instrument has successfully calculated its internal error factor, and will compensate for this value in any subsequent measurements. When performing a “probe zero”, the instrument will always use the sound velocity value of the built-in probe-disc, even if some other velocity value has been entered for making actual measurements. Though the instrument will remember the last “probe zero” performed, it is generally a good idea to perform a “probe zero” whenever the gauge is turned on, as well as any time a different transducer is used. This will ensure that the instrument is always correctly zeroed.

Press  while in probe zero mode will stop current probe zero operation and return to the measurement mode.

### **4.3 Sound Velocity Calibration**

In order for the gauge to make accurate measurements, it must be set to the correct sound velocity for the material being measured. Different types of material have different inherent sound velocities. If the gauge is not set to the correct sound velocity, all of the measurements the gauge makes will be erroneous by some fixed percentage. The





**One-Point** calibration is the simplest and most commonly used calibration procedure optimizing linearity over large ranges. The **Two-point** calibration allows for greater accuracy over small ranges by calculating the probe zero and velocity.

**Note: One** and **Two** point calibrations must be performed on material with the paint or coating removed. Failure to remove the paint or coating prior to calibration will result in a multi material velocity calculation that may be different from the actual material velocity intended to be measured.

#### **4.3.1 Calibration to a known thickness**







Note: This procedure requires a sample piece of the specific material to be measured, the exact thickness of which is known, e.g. from having been measured by some other means.

- 1) Perform a Probe-Zero.
- 2) Apply couplant to the sample piece.
- 3) Press the transducer against the sample piece, making sure that the transducer sits flat against the surface of the sample. The display should show some thickness value, and the coupling status indicator should appear steadily.
- 4) Having achieved a stable reading, remove the transducer. If the displayed thickness changes from the value shown while the transducer was coupled, repeat step 3.
- 5) Press the  key to activate the calibration mode. The MM (or IN) symbol should begin flashing.

- 6) Use the  key and the  key to adjust the displayed thickness up or down, until it matches the thickness of the sample piece.
- 7) Press the  key again. The M/S (or IN/ $\mu$ S) symbols should begin flashing. The gauge is now displaying the sound velocity value it has calculated based on the thickness value that was entered.
- 8) Press the  key once again to exit the calibration mode and return to the measurement mode. The gauge is now ready to perform measurements.

#### 4.3.2 Calibration to a known velocity

Note: This procedure requires that the operator knows the sound velocity of the material to be measured. A table of common materials and their sound velocities can be found in Appendix A of this manual.





- 1) Press the  key to activate the calibration mode. The MM (or IN) symbol should begin flashing.
- 2) Press the  key again, so that The M/S (or IN/ $\mu$ S) symbols are flashing.
- 3) Use the  key and the  key to adjust the sound velocity value up or down, until it matches the sound velocity of the material to be measured. You can also press the  key to switch among the preset commonly using velocities.
- 4) Press the  key to exit from the calibration mode. The gauge is now ready to perform measurements.



To achieve the most accurate measurements possible, it is generally advisable to always calibrate the gauge to a

sample piece of known thickness. Material composition (and thus, its sound velocity) sometimes varies from lot to lot and from manufacturer to manufacturer. Calibration to a sample of known thickness will ensure that the gauge is set as closely as possible to the sound velocity of the material to be measured.

### 4.3.3 Two Point Calibration

Note: This procedure requires that the operator has two known thickness points on the test piece that are representative of the range to be measured.

- 1) Perform a Probe-Zero.
- 2) Apply couplant to the sample piece.
- 3) Press the transducer against the sample piece, at the first/second calibration point, making sure that the transducer sits flat against the surface of the sample. The display should show some (probably incorrect) thickness value, and the coupling status indicator should appear steadily.
- 4) Having achieved a stable reading, remove the transducer. If the displayed thickness changes from the value shown while the transducer was coupled, repeat step 3.
- 5) Press the  key. The MM (or IN) symbol should begin flashing.
- 6) Use the  key and the  key to adjust the displayed thickness up or down, until it matches the thickness of the sample piece.
- 7) Press the  key. The display will flash 1OF2. Repeat steps 3 through 6 on the second calibration point.

- 8) Press the  key, so that The M/S (or IN/  $\mu$  S) symbols are flashing. The gauge will now display the sound velocity value it has calculated based on the thickness values that were entered in step 6.
- 9) Press the  key once more to exit the calibration mode. The gauge is now ready to perform measurements within this range.

#### **4.4 Making Measurements**

When the tool is displaying thickness measurements, the display will hold the last value measured, until a new measurement is made.

In order for the transducer to do its job, there must be no air gaps between the wear-face and the surface of the material being measured. This is accomplished with the use of a “coupling” fluid, commonly called “couplant”. This fluid serves to “couple”, or transfer, the ultrasonic sound waves from the transducer, into the material, and back again. Before attempting to make a measurement, a small amount of couplant should be applied to the surface of the material being measured. Typically, a single droplet of couplant is sufficient.

After applying couplant, press the transducer (wearface down) firmly against the area to be measured. The coupling status indicator should appear, and a digit number should appear in the display. If the instrument has been properly “zeroed” and set to the correct sound velocity, the number in the display will indicate the actual thickness of the material directly beneath the transducer.

If the coupling status indicator does not appear, not

stable, or the numbers on the display seem erratic, firstly check to make sure that there is an adequate film of couplant beneath the transducer, and that the transducer is seated flat against the material. If the condition persists, it may be necessary to select a different transducer (size or frequency) for the material being measured.

While the transducer is in contact with the material that is being measured, the instrument will perform four measurements every second, updating its display as it does so. When the transducer is removed from the surface, the display will hold the last measurement made.

**Note :** Occasionally, a small film of couplant will be drawn out between the transducer and the surface as the transducer is removed. When this happens, the gauge may perform a measurement through this couplant film, resulting in a measurement that is larger or smaller than it should be. This phenomenon is obvious when one thickness value is observed while the transducer is in place, and another value is observed after the transducer is removed. In addition, measurements through very thick paint or coatings may result in the paint or coating being measured rather than the actual material intended. The responsibility for proper use of the instrument, and recognition of these types of phenomenon, rests solely with the user of the instrument.

#### **4.5 Scan mode**

While the gauge excels at making single point measurements, it is sometimes desirable to examine a larger region, searching for the thinnest point. The gauge

includes a feature, called Scan Mode, which allows it to do just that.

In normal operation, the gauge performs and displays four measurements every second, which is quite adequate for single measurements. In Scan Mode, however, the gauge performs ten measurements every second, and displays the readings while scanning. While the transducer is in contact with the material being measured, the gauge is keeping track of the lowest measurement it finds. The transducer may be “scrubbed” across a surface, and any brief interruptions in the signal will be ignored. When the transducer loses contact with the surface for more than two seconds, the gauge will display the smallest measurement it found. When the transducer is removed from the material being scanned, the gauge will display the smallest measurement it found.

When the scan mode is turned off, the single point mode will be automatically turned on. Turn on/off the scan mode by the following steps:

Press the  key to switch the scan measurement mode on and off. It will display the current condition of the scan mode on the main screen.

## **4.6 Changing Resolution**

ST160 has selectable display resolution, which is 0.1mm and 0.01mm. This function is not available for ST150, which is fixed to 0.1mm.

Press down the  key while turning on the gauge will switch the resolution between “High” and “Low”.





## 4.7 Changing Units

On the measurement mode, press the  key to switch back and forth between imperial and metric units.

## 4.8 Memory Management





### 4.8.1 Storing a reading

There are twenty files (F00-F19) that can be used to store the measurement values inside the gauge. At most 100 records (thickness values) can be stored to each file. By simply pressing the  key after a new measurement reading appears, the measured thickness value will be saved to current file. It is added as the last record of the file. To change the destination file to store the measured values, follow the steps:

- 1) Press the  key to activate the data logging functions. It will display the current file name and the total record count of the file.
- 2) Use the  key and the  key to select the desired file to set as current file.
- 3) Press the  key to exit the data logging functions at any time.









### 4.8.2 Clearing selected file

The user may require the contents of an entire file be completely cleared of all measurements. This would allow the user to start a new list of measurements starting at storage location L00. The procedure is outlined in the following steps.

1. Press the  key to activate the data logging functions. It will display the current file name and the total record count of the file.
2. Use the  key and the  key to scroll to the file that will be cleared of all measurements.
3. Press the  key on the desired file. It will automatically clear the file, and display “-DEL”.
4. Press the  key, at any time, to exit the data logging functions and return to measurement mode.





#### 4.8.3 Viewing/deleting stored record

This function provides the user with the ability to view/delete a record in a desired file previously saved in memory. Following is the steps:

1. Press the  key to activate the data logging functions. It will display the current file name and the total record count of the file.
2. Use the  key and the  key to select the desired file.
3. Press the  key to enter the selected file. It will display the current record number (for example, L012) and the record content.
4. Use the  key and the  key to select the desired record.
5. Press the  key on the desired record. It will automatically delete this record, and display “-DEL”.
6. Press the  key to exit the data logging functions and return to measurement mode.

## 4.9 Data Printing

At the end of the inspection process, or end of the day, the user may require the readings be transferred to a computer. The following steps outline this procedure. This function is only available for ST160, and not for ST150.

1. Before printing, please insert one connection plug of the print cable (Optional parts) into the socket on the up-left of the main body, and insert the other plug into the communication socket of the mini-printer.
2. Press the  key to activate the data logging functions.
3. Use the  key and the  key to select the desired file.
4. Press the  key to print the selected file. This operation will send all the data in current file to the mini printer via RS232 port and print them out.
5. Press the  key to exit the data logging functions and return to measurement mode.

## 4.10 Beep Mode

When the beep is set to **【On】**, it would make a short hoot while press the key each time, on each measurement, or the measured value exceeds the tolerance limit.



Press the  key to switch the beep mode on and off. It will display the current beep mode on the main screen.

## 4.11 EL Backlight

With the background light, it is convenient to work in the dark condition. Press key  to switch on or switch off the background light at any moment as you need after power on.

Since the EL light will consume much power, turn on it only when necessary.

## 4.12 Battery Information

Two AA size alkaline batteries are needed as the power source. After several hours' usage of the preset batteries, the battery symbol on the screen will be shown as . The more of dark part indicates the more close to fill. When the battery capacity runs out, the battery symbol will be shown as  and will begin to flash. When this occurs, the batteries should be replaced.

Please take out the batteries when not working during a long period of time.

## 4.13 Auto Power Off

The instrument features an auto power off function designed to conserve battery life. If the tool is idle for 5 minutes, it will turn itself off. While the voltage of the battery is too low this function will also work.

## 4.14 System Reset

Press down the  key while powering on the instrument will restore factory defaults. All the memory data will be cleared during system reset. The only time this might possibly helpful is if the parameter in the gauge was somehow corrupted.

## 4.15 Connecting to a Computer

ST160 is equipped with a RS232 serial port. Using the accessory cable, the gauge has the ability to connect to a computer, or external storage device. Measurement data stored in the memory of the gauge can be transferred to the

computer through the RS232 port. Detailed information of the communication software and its usage refer to the software manual.

## **5 Servicing**

When the hardness tester appears some other abnormal phenomena, please do not dismantle or adjust any fixedly assembled parts. Fill in and present the warranty card to us. The warranty service can be carried on.

## **6 Transport and Storage**

- 1) Keep it away from vibration, strong magnetic field, corrosive medium, dampness and dust. Storage in ordinary temperature.
- 2) With original packing, transport is allowed on the third grade highway.

## Appendix A Sound Velocities

Material	Sound Velocity	
	in/ $\mu$ s	m/s
Aluminum	0.250	6340-6400
Steel, common	0.233	5920
Steel, stainless	0.226	5740
Brass	0.173	4399
Copper	0.186	4720
Iron	0.233	5930
Cast Iron	0.173-0.229	4400 - 5820
Lead	0.094	2400
Nylon	0.105	2680
Silver	0.142	3607
Gold	0.128	3251
Zinc	0.164	4170
Titanium	0.236	5990
Tin	0.117	2960
Epoxy resin	0.100	2540
Ice	0.157	3988
Nickel	0.222	5639
Plexiglass	0.106	2692

Polystyrene	0.092	2337
Porcelain	0.230	5842
PVC	0.094	2388
Quartz glass	0.222	5639
Rubber, vulcanized	0.091	2311
Teflon	0.056	1422
Water	0.058	1473

## Appendix B Applications Notes

### Measuring pipe and tubing.

When measuring a piece of pipe to determine the thickness of the pipe wall, orientation of the transducers is important. If the diameter of the pipe is larger than approximately 4 inches, measurements should be made with the transducer oriented so that the gap in the wearface is perpendicular (at right angle) to the long axis of the pipe. For smaller pipe diameters, two measurements should be performed, one with the wearface gap perpendicular, another with the gap parallel to the long axis of the pipe. The smaller of the two displayed values should then be taken as the thickness at that point.



Perpendicular

Parallel

### **Measuring hot surfaces**

The velocity of sound through a substance is dependant upon its temperature. As materials heat up, the velocity of sound through them decreases. In most applications with surface temperatures less than about 100 °C, no special procedures must be observed. At temperatures above this point, the change in sound velocity of the material being measured starts to have a noticeable effect upon ultrasonic measurement. At such elevated temperatures, it is recommended that the user perform a calibration procedure on a sample piece of known thickness, which is at or near the temperature of the material to be measured. This will allow the gauge to correctly calculate the velocity of sound through the hot material.

When performing measurements on hot surfaces, it may also be necessary to use a specially constructed high-temperature transducer. These transducers are built using materials which can withstand high temperatures. Even so, it is recommended that the probe be left in contact with the surface for as short a time as needed to acquire a stable measurement. While the transducer is in contact with a hot surface, it will begin to heat up, and through thermal

expansion and other effects, may begin to adversely affect the accuracy of measurements.

### **Measuring laminated materials.**

Laminated materials are unique in that their density (and therefore sound-velocity) may vary considerably from one piece to another. Some laminated materials may even exhibit noticeable changes in sound-velocity across a single surface. The only way to reliably measure such materials is by performing a calibration procedure on a sample piece of known thickness. Ideally, this sample material should be a part of the same piece being measured, or at least from the same lamination batch. By calibrating to each test piece individually, the effects of variation of sound-velocity will be minimized.

An additional important consideration when measuring laminates, is that any included air gaps or pockets will cause an early reflection of the ultrasound beam. This effect will be noticed as a sudden decrease in thickness in an otherwise regular surface. While this may impede accurate measurement of total material thickness, it does provide the user with positive indication of air gaps in the laminate.

### **Suitability of materials**

Ultrasonic thickness measurements rely on passing a sound wave through the material being measured. Not all materials are good at transmitting sound. Ultrasonic thickness measurement is practical in a wide variety of materials including metals, plastics, and glass. Materials that are difficult include some cast materials, concrete, wood, fiberglass, and some rubber.

## **Couplants**

All ultrasonic applications require some medium to couple the sound from the transducer to the test piece. Typically a high viscosity liquid is used as the medium. The sound used in ultrasonic thickness measurement does not travel through air efficiently.

A wide variety of couplant materials may be used in ultrasonic gauging. Propylene glycol is suitable for most applications. In difficult applications where maximum transfer of sound energy is required, glycerin is recommended. However, on some metals glycerin can promote corrosion by means of water absorption and thus may be undesirable. Other suitable couplants for measurements at normal temperatures may include water, various oils and greases, gels, and silicone fluids. Measurements at elevated temperatures will require specially formulated high temperature couplants.

Inherent in ultrasonic thickness measurement is the possibility that the instrument will use the second rather than the first echo from the back surface of the material being measured while in standard pulse-echo mode. This may result in a thickness reading that is TWICE what it should be. The Responsibility for proper use of the instrument and recognition of these types of phenomenon rests solely with the user of the instrument.